

BuildUp Pods and Pavillions R4, R8, R12

Open Pod

Design: Kauppi & Kauppi



GLIMAKRA
OF SWEDEN

BuildUp Meeting Pods & Pavillions is a collection of large-scale, acoustic meeting rooms. A design characterized by openness, functionality, and accessibility – with a mission to create inviting meeting places that also divides and defines large interiors. The fabric covered wall elements have an equally good sound absorption on insides and outsides, which means that the meeting rooms also serve as an effective acoustic solution for the greater interior surrounding the pods. The walls acoustic task is to reduce reverberation time, to achieve pleasant sound atmospheres. The pods have generous entrances without thresholds that closes with curtains. To enable dynamic and creative meetings, the concepts pods and pavilion are equipped with several details, such as white board, monitor bracket, LED light-strips, power outlets and hidden cable routing. All units have a self-supporting construction, which is quick and easy to build and install.



BuildUp Pod R4 | Meeting



BuildUp Pod R8 | Meeting



BuildUp Pavillion R4 | Meeting



BuildUp Pod R12 | Meeting

BuildUp Pods and Pavillions R4, R8, R12

Open Pod

Design: Kauppi & Kauppi



GLIMAKRA
OF SWEDEN

DIMENSIONS

BuildUp Pod R4 | Meeting (10 m², 4-6 persons)

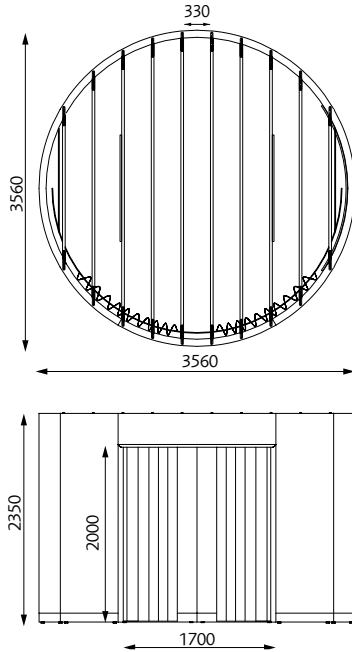

BuildUp Pod R8 | Meeting (17 m², 8-10 persons)

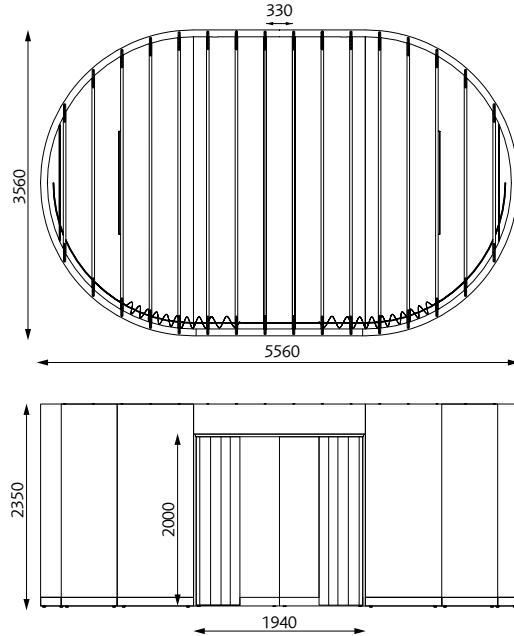

BuildUp Pavillion R4 | Meeting (5 m², 4-6 persons)

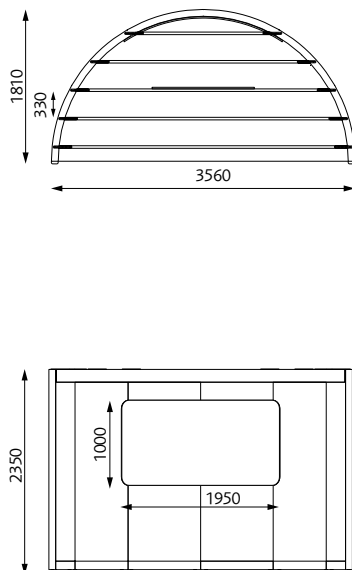

BuildUp Pod R12 | Meeting (20 m², 12-14 persons)

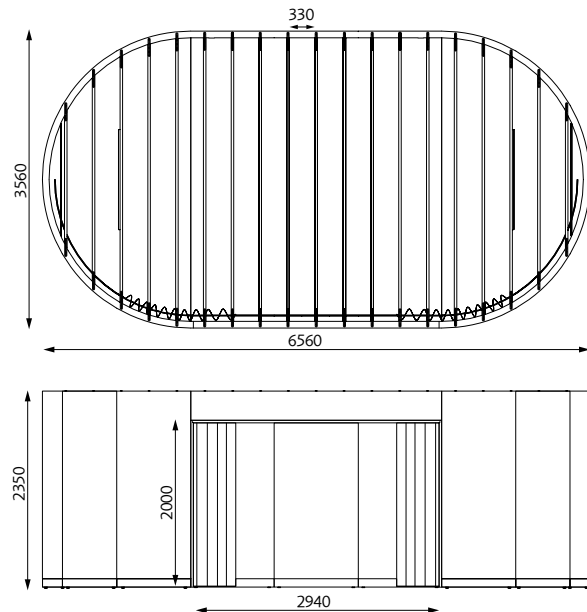

BuildUp Pods and Pavillions R4, R8, R12

Open Pod

Design: Kauppi & Kauppi



DESCRIPTION

Straight and curved upholstered screens with a width of 1000 mm or a radius of 1780 mm, 30°.

Height: 2350 mm (screen incl. plinth) + adjustable feet

Plinth with adjustable feet: black metal, height 100 mm.

Upholstery: Furniture nailed with fabric on both sides.

See Product sheet Fabric and Piping.pdf for our standard fabrics, the sheet is available here:

<https://glimakra.com/en/download/>.

Frame straight screens: 2 x 35 mm sound absorbing polyether (Oeko-Tex) glued on both sides of an 8 mm sound reducing MDF board with an 80 mm solid wooden frame.

Frame curved screens: 75 mm recycled polyether from own production inside two sheets of perforated masonite and an 80 mm solid wooden frame.

Ceiling beams: finger-jointed pine, 30 x 138 mm, 10% white. 100% recyclable materials.

MOUNTING

All pods have a completely self-supporting construction, which means that no floor, wall or ceiling attachments are necessary.

Adjustment feet are included to compensate for uneven floors. The Pods are easy to build and move if a new location is desired. The screens are connected with hidden special fittings. Allen key included.

The plinth is mounted on the screen upon delivery. An acoustic strip is attached under the plinth around the entire room. Delivered on a roll.

Installation, repair and maintenance of electricity to the sockets, switches and lighting may only be carried out by a qualified electrician. Wiring is done in the plinth and in integrated flex pliable conduits in the screens. Electricity for lamps and lighting is drawn on top of the ceiling beams.

Mounting write board: Suspension with aluminium strip that is screwed with wooden screws in the frames of the curved screens.



Wall mount TV: Requires a mounting plate for the TV wall mount which is screwed on with wooden screws in the frames between two screens.

CERTIFICATES

Möbelfakta: The product meets the requirements for environment and responsible supply chains defined by Möbelfakta.

Glimakra of Sweden AB is certified according to ISO 9001:2015 and ISO 14001:2015.



SPECIFICATION TEXT

E.g: BuildUp Pod R4 | Meeting. Diameter: 3560 mm, height: 2350 mm (screen incl. plinth).

Fabric: Remix Screen C0328

Curtain: Vescom Bedra 8059.14

Carpet: Ogeborg Foris/Essential 1031 - 8J82

Curved write board and wall mount for TV.

BuildUp Pods and Pavillions R4, R8, R12

Open Pod

Design: Kauppi & Kauppi



BuildUp Pod R4 | Meeting

(10 m², 4-6 persons)

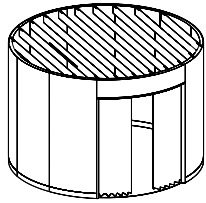

Delivered complete with:

- 2 LED-Light strips connected to switch. 24V LED Lighting 19.2W / m, 3000K, white light
- 1 electrical outlet in the plinth
- Ceiling-mounted curtain rail: black for two curtains, 2700 mm, radius 1620 mm Waveglid 8/6

OPTIONS

Curved magnetic write board (radius 1700 mm, 1950 x 1000 mm with radius 100 mm in the corners).

Wall Mount Turn 180° (maximum load 30 kg) and power outlet for TV.

Dim out curtains: Vescom Bedra

Other curtains on request. 2 pcs à 340 cm, length 216 cm, hook 8/6.

Carpet: Ogeborg Foris / Essential 1031 (5.8 mm) molded diameter 342 cm.

Floor list: black aluminium, can be used to hide electrical cables between table and screen.

See page 6-7 for colour choices on carpet and curtains.

BuildUp Pavillion R4 | Meeting

(5 m², 4-6 persons)

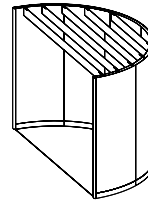

Delivered complete with:

- 1 LED-Light strip connected to switch. 24V LED Lighting 19.2W / m, 3000K, white light
- 1 electrical outlet in the plinth

OPTIONS

Curved magnetic write board (radius 1700 mm, 1950 x 1000 mm with radius 100 mm in the corners).

Wall Mount Turn 180° (maximum load 30 kg) and power outlet for TV.

Floor list: black aluminium, can be used to hide electrical cables between table and screen.

See page 6-7 for colour choices on carpet.

BuildUp Pods and Pavillions R4, R8, R12

Open Pod

Design: Kauppi & Kauppi

BuildUp Pod R8 | Meeting

(17 m², 8-10 persons)

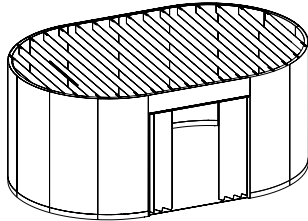

Delivered complete with:

- 2 LED-Light strips connected to switch. 24V LED Lighting 19.2W / m, 3000K, white light
- 1 electrical outlet in the plinth
- Ceiling-mounted curtain rail: black for two curtains, 2700 mm, Waveglid 8/6

OPTIONS

Curved magnetic write board (radius 1700 mm, 1950 x 1000 mm with radius 100 mm in the corners).

Wall Mount Turn 180° (maximum load 30 kg) and power outlet for TV.

Dimout curtains: Vescom Bedra

Other curtains on request. 2 pcs à 340 cm, length 216 cm, hook 8/6.

Electrical driven curtain rail on request.

Floor list: black aluminium, can be used to hide electrical cables between table and screen.

See page 6-7 for colour choices on carpet and curtains.

BuildUp Pod R12 | Meeting

(20 m², 12-14 persons)

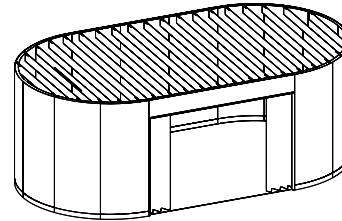

Delivered complete with:

- 2 LED-Light strips connected to switch. 24V LED Lighting 19.2W / m, 3000K, white light
- 1 electrical outlet in the plinth
- Ceiling-mounted curtain rail: black for two curtains, 3700 mm, Waveglid 8/6

OPTIONS

Curved magnetic write board (radius 1700 mm, 1950 x 1000 mm with radius 100 mm in the corners).

Wall Mount Turn 180° (maximum load 30 kg) and power outlet for TV.

Dimout curtains: Vescom Bedra

Other curtains on request. 2 pcs à 370 cm, length 216 cm, hook 8/6.

Electrical driven curtain rail on request.

Floor list: black aluminium, can be used to hide electrical cables between table and screen.

See page 6-7 for colour choices on carpet and curtains.

BuildUp Pods and Pavillions R4, R8, R12

Open Pod

Design: Kauppi & Kauppi



GLIMAKRA
OF SWEDEN

CARPET

Ogeborg: Foris/Essential 1031 (5,8mm)

100 % polyamide

Tufted, looped fringe

Approved by Byggsvarubedömningen

Fire class:Cfl-s1

Drawings available on request.

With long tone in tone, 23 colours.

The carpet continues 10 mm under the screen.

The carpet should be rolled up once before laying.

Other carpets on request.

Photographic scans are displayed as a guide and colour variations may occur. If needed, we advise you request actual fabric samples before ordering.

Read more: www.ogeborg.se/kollektion/foris-essential-1031

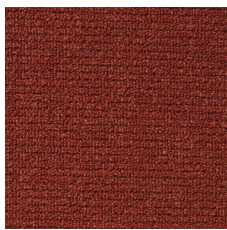

1031 - 1M74

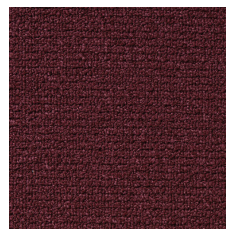

1031 - 1M76

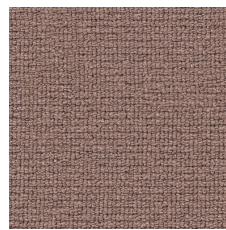

1031 - 1N22

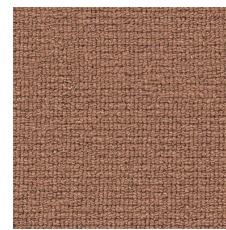

1031 - 1N23

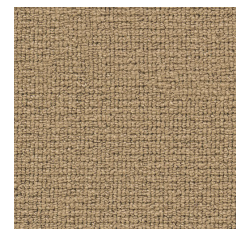

1031 - 2F27



1031 - 2F29



1031 - 3P74



1031 - 3P75



1031 - 3P78

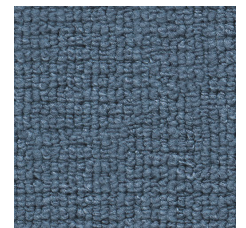

1031 - 3Q41

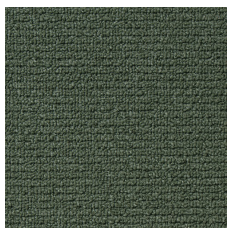

1031 - 4G29

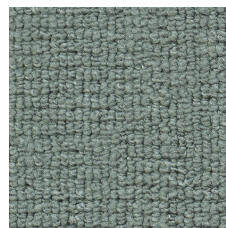

1031 - 4G65

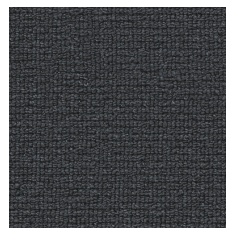

1031 - 5W57



1031 - 5W58

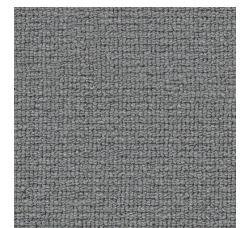

1031 - 5W59

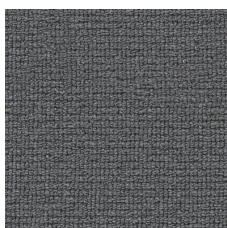

1031 - 5W60



1031 - 7G21

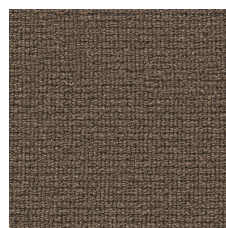

1031 - 8J46



1031 - 8J47

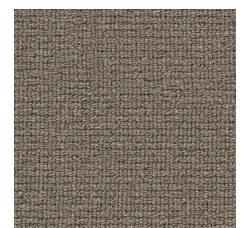

1031 - 8J82



1031 - 8J83



1031 - 9F57



1031 - 9F58

BuildUp Pods and Pavillions R4, R8, R12

Open Pod

Design: Kauppi & Kauppi



DIM. OUT CURTAIN

Vescom: Bedra

Material: 100% fire protected polyester

Fire class: EN 13773, class 1 BS 5867 – 2, typ C NF P 92 / 503
– 507, M1 DIN 4102, B1 UNI VF 8456 – 8457, class 1 NFPA
701 CAN / ULC S109 IMO 2010 FTP del 2010

Colour fastness to artificial light: DIN EN ISO 105-B02: 6

Washing instructions:



krympning: varp -0,4% / väft -1,4%



krympning: varp -2,5% / inslag -1,5%

More information is available here:

<https://www.vescom.com/en/dessin/bedra>

For more information contact order@glimakra.com



BuildUp Pods and Pavillions R4, R8, R12

Open Pod

Design: Kauppi & Kauppi



GLIMAKRA
OF SWEDEN



PRODUCT SHEET / 2022 05 16

BuildUp Pods and Pavillions R4, R8, R12

Open Pod

Design: Kauppi & Kauppi



GLIMAKRA
OF SWEDEN



PRODUCT SHEET / 2022 05 16

BuildUp Pods and Pavillions R4, R8, R12

Open Pod

Design: Kauppi & Kauppi



GLIMAKRA
OF SWEDEN

