

BuildUp Pods R1 & R2

Open Pod

Design: Kauppi & Kauppi



GLIMAKRA
OF SWEDEN

BuildUp Pod R1 and R2 are characterized by openness, functionality, and accessibility – with the mission to create inviting working and meeting spaces, and to contribute to pleasant sound atmospheres. Semi-muted, subdued acoustic rooms with an equally airy feeling as embracing cosiness, with the same design as the previously launched BuildUp system. The rounded shaped R2 is offered in two different configurations. The Coupé version is designed to host work sessions or informal meetings for two persons or more, with facing sofas and a centered pillar table. R2 Work is prepared for one person in need of a private space, furnished with both a desk and a sofa for reading and recreational pauses. As the name suggests, the round R1 is intended for one individual in demand for a small personal corner. Available with either a desk or a comfortable sofa - providing a calm, semi-muted space without visual distraction. All BuildUp Pods can also be delivered as empty rooms, ready to be custom furnished by architects. All pods have generous entrances without thresholds that closes with curtains. The spaces are pleasantly lit by integrated LED light-strips between the wooden ceiling beams, combined with additional lighting on wall or table. Conveniently placed power outlets makes it easy for users to plug in various devices. The fabric covered wall elements have equally good sound absorption on the inside as on the outside, which means that the pods also serve as an efficient acoustic solution for the greater surrounding interior. The self-supporting construction is quick and easy to install.



BuildUp Pod R1



BuildUp Pod R1 | Read



BuildUp Pod R1 | Work



BuildUp Pod R2



BuildUp Pod R2 | Coupé



BuildUp Pod R2 | Work

BuildUp Pods R1 & R2

Open Pod

Design: Kauppi & Kauppi



GLIMAKRA
OF SWEDEN

DIMENSIONS

BuildUp Pod R1

(1-2 persons)

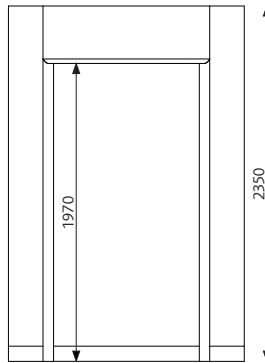
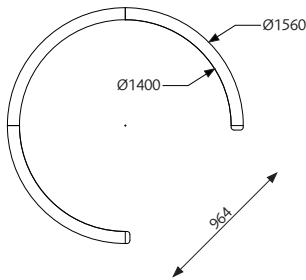
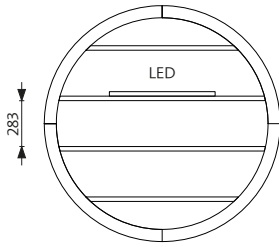

BuildUp Pod R1 | Read & Work

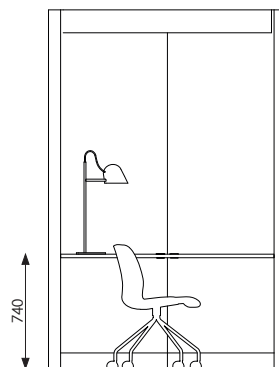
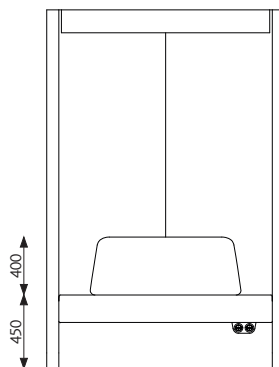
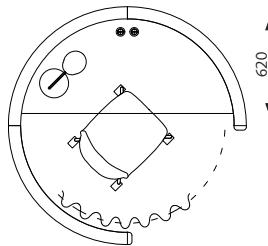
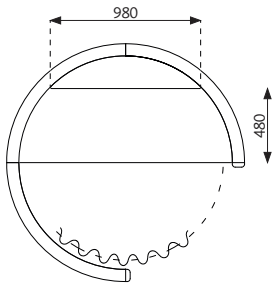

BuildUp Pods R1 & R2

Open Pod

Design: Kauppi & Kauppi

BuildUp Pod R1

(1-2 persons)

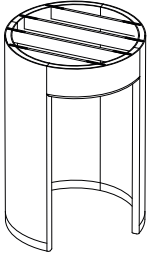

Delivered complete with:

- 1 LED-Light strip which is connected to switch. 24V LED Lighting 19.2W / m, 3000K, white light. Driver 24V 60W.
- Ceiling-mounted curtain rail: black for one curtain, 1700 mm, radius 1340 mm, Waveglid 8/6

OPTIONS

Carpet: Ogeborg Foris / Essential 1031 (5.8mm) form fitted diameter 142cm.

Curtain: Dim out Vescom Bedra.

Other curtains on request. 340 cm, length 216 cm, hook 8/6.

See page 7-8 for colour choices on carpet and curtains.

Worktop: Pod Work is available in linoleum or laminate.

BuildUp Pod R1 | Read

Pod Sofa: Form fitted sofa for 1-2 persons.

Width 1400mm, seat depth 480mm. Back cushion 400mm high.

Base in ash with Power Dot midi.

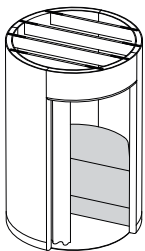

BuildUp Pod R1 | Work

Pod Work: Form fitted worktop 1390x620x25mm.

Radius 700mm

Ash or linoleum with edge in clear lacquered MDF with 2 Power Dot midi.

Height 740mm. Fixed mounted.

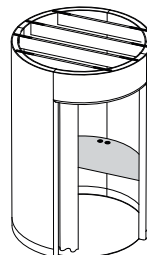

BuildUp Pods R1 & R2

Open Pod

Design: Kauppi & Kauppi



GLIMAKRA
OF SWEDEN

BuildUp Pod R2

(1-4 persons)

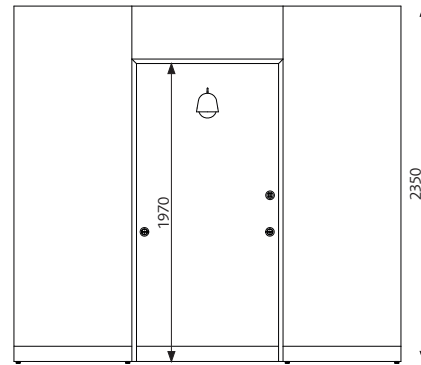
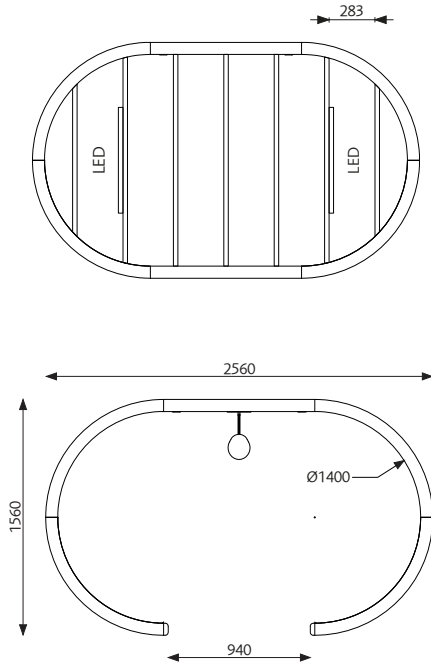

BuildUp Pod R2 | Coupé & Work

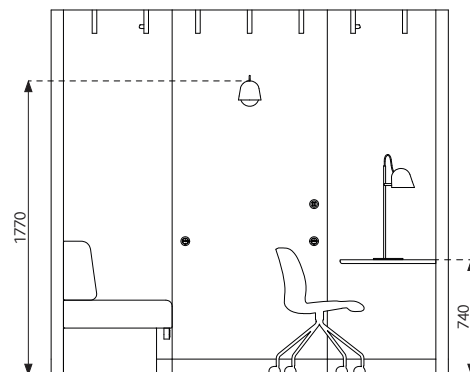
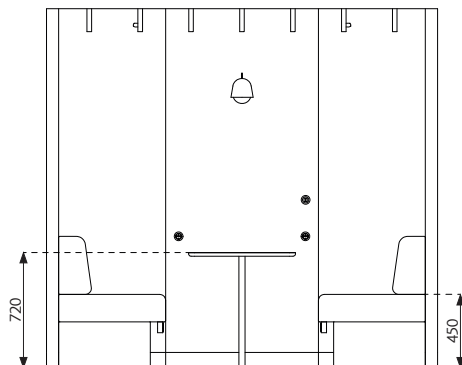
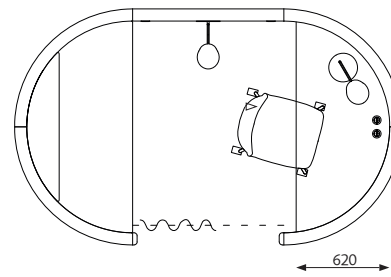
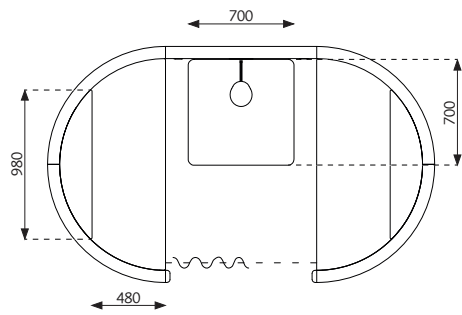

BuildUp Pods R1 & R2

Open Pod

Design: Kauppi & Kauppi

BuildUp Pod Pod R2

(1-4 persons)

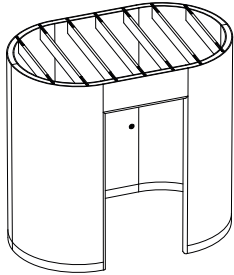

Delivered complete with:

- 2 LED-Light strips which are connected to switch. 24V LED Lighting 19.2W / m, 3000K, white light. Drivers 24V 60W.
- Wall lamp "Streck", fixed mounting connected to switch. Black RAL 9005 with brass details. Switch inside shade, adjustable shade. 1 x 6W LED module 2700K 660lm (included).
- 2 electrical outlets in the screen
- Ceiling-mounted curtain rail: black for one curtain, 1350 mm, Waveglid 8/6

OPTIONS

Carpet: Ogeborg Foris / Essential 1031 (5.8mm) form fitted diameter 242x142cm.

Curtains: Dim out Vescom Bedra.

Other curtains on request. 260 cm, length 216 cm, hook 8/6.

See page 7-8 for colour choices on carpet and curtains.

BuildUp Pod R2 | Coupé

2 Pod Sofa: Form fitted sofa for 1-2 persons.

Width 1400mm, seat depth 480mm. Back cushion 400mm high.

Base in ash with Power Dot midi.

1 Coupé Table 700x700mm ash.

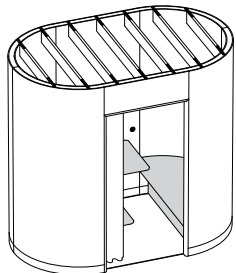

BuildUp Pod R2 | Work

1 Pod Work: Form fitted worktop 1390x620x25mm.

Radius 700mm

Ash or linoleum with edge in clear lacquered MDF with 2 Power Dot midi.

Height 740mm. Fixed mounted.

1 Pod Sofa: Form fitted sofa for 1-2 persons.

Width 1400mm, seat depth 480mm. Back cushion 400mm high.

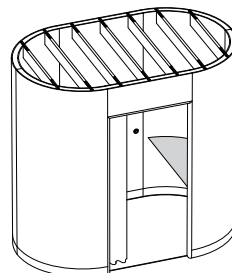

BuildUp Pods R1 & R2

Open Pod

Design: Kauppi & Kauppi



DESCRIPTION

R1 Pod: 3 curved screens with a radius of 700mm, 90 ° connected with hidden special fittings.

R2 Pod: 1 straight screen 1000mm and 4 curved screens with a radius of 700mm, 90 ° connected with hidden special fittings.

Height: 2350mm (screen incl. plinth) + adjustable feet

Plinth with adjustable feet: black metal, height 100mm.

Upholstery: Furniture nailed with fabric on both sides.

See Product sheet Fabric and Piping.pdf for our standard fabrics, the sheet is available here:

<https://glimakra.com/en/download/>.

Frame straight screen: 2 x 35mm sound absorbing polyether (Oeko-Tex) glued on both sides of an 8mm sound reducing MDF board with an 80mm solid wooden frame.

Frame curved screens: 75mm recycled polyether from own production inside two sheets of perforated masonite and an 80mm solid wooden frame.

Ceiling beams: finger-jointed pine, 30 x 138mm, 10% white. 100% recyclable materials.

MOUNTING

All pods have a completely self-supporting construction, which means that no floor, wall or ceiling attachments are necessary.

Adjustment feet are included to compensate for uneven floors. The Pods are easy to build and move if a new location is desired. The screens are connected with hidden special fittings. Allen key included.

The plinth is mounted on the screen upon delivery. An acoustic strip is attached under the plinth around the entire room. Delivered on a roll.

Installation, repair and maintenance of electricity to the sockets, switches and lighting may only be carried out by a qualified electrician. Wiring is done in the plinth and in integrated flex pliable conduits in the screens. Electricity for lamps and lighting is drawn on top of the ceiling beams.

The curtain rail is mounted 60mm inside the screen and the curtain is hung with the right side inwards.

CERTIFICATES

Möbelfakta: The product meets the requirements for environment and responsible supply chains defined by Möbelfakta.

Glimakra of Sweden AB is certified according to ISO 9001:2015 and ISO 14001:2015.



SPECIFICATION TEXT

E.g: BuildUp Pod R2 | Work . 2560x1560mm, height: 2350mm (screen incl. plinth).

Fabric: Remix Screen 328

Curtain: Vescom Bedra 8059.14.

Carpet: Ogeborg Foris / Essential 1031 - 8J82.

Furnishings: 1 Pod Work worktop in ash, 1 Pod Sofa Remix 326.

Atmospheric lighting: wall lamp and table lamp Streck from Örsjö belysning.

BuildUp Pods R1 & R2

Open Pod

Design: Kauppi & Kauppi

CARPET

Ogeborg: Foris/Essential 1031 (5,8mm)

100 % polyamide

Tufted, looped fringe

Approved by Byggarbetsnämningen

Fire class:Cfl-s1

Drawings available on request.

With edge tone in tone, 23 colours.

The carpet continues 1cm under the screen.

The carpet should be rolled up once before laying.

Other carpets on request.

Photographic scans are displayed as a guide and colour variations may occur. If needed, we advise you request actual fabric samples before ordering.

Read more: www.ogeborg.se/kollektion/foris-essential-1031

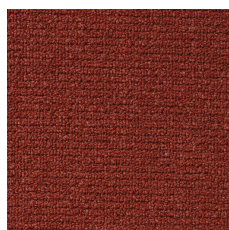

1031 - 1M74

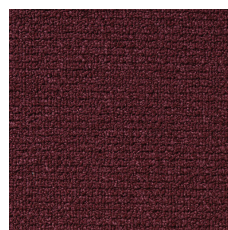

1031 - 1M76

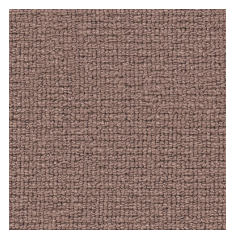

1031 - 1N22

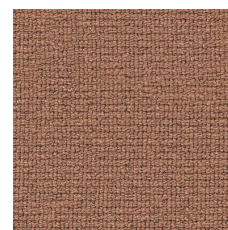

1031 - 1N23



1031 - 2F27



1031 - 2F29



1031 - 3P74

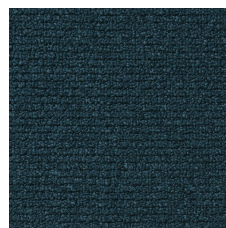

1031 - 3P75



1031 - 3P78

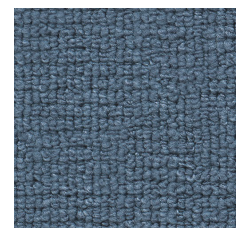

1031 - 3Q41

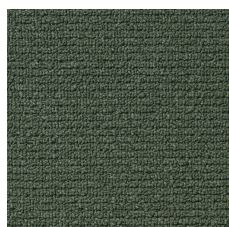

1031 - 4G29

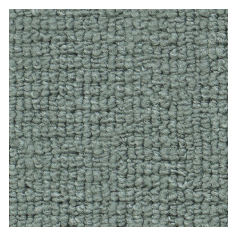

1031 - 4G65

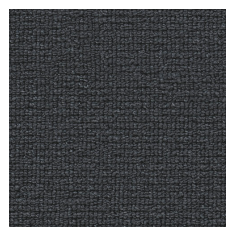

1031 - 5W57

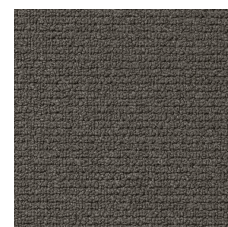

1031 - 5W58

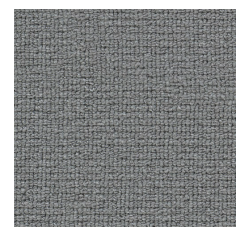

1031 - 5W59

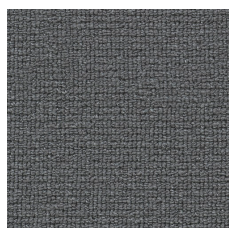

1031 - 5W60



1031 - 7G21



1031 - 8J46



1031 - 8J47

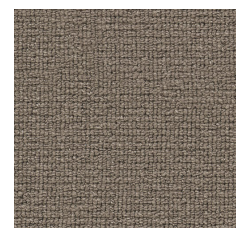

1031 - 8J82



1031 - 8J83



1031 - 9F57



1031 - 9F58

BuildUp Pods R1 & R2

Open Pod

Design: Kauppi & Kauppi



DIM. OUT CURTAIN

Vescom: Bedra

Material: 100% fire protected polyester

Fire class: EN 13773, class 1 BS 5867 – 2, typ C NF P 92 / 503
– 507, M1 DIN 4102, B1 UNI VF 8456 – 8457, class 1 NFPA
701 CAN / ULC S109 IMO 2010 FTP del 2010

Colour fastness to artificial light: DIN EN ISO 105-B02: 6

Washing instructions:



krympning: varp -0,4% / väft -1,4%



krympning: varp -2,5% / inslag -1,5%

More information is available here:

<https://www.vescom.com/en/dessin/bedra>

For more information contact order@glimakra.com



PRODUCT SHEET / 2022 08 10

BuildUp Pods R1 & R2

Open Pod

Design: Kauppi & Kauppi



GLIMAKRA
OF SWEDEN

