

PUNCTUAL SHELVING SYSTEM

PRODUCT INFO



ferm
L I V I N G



Punctual SHELVING SYSTEM

Punctual is a high-quality modular shelving system made from powder coated metal that is designed to grow with you and your home. Our idea was to create an easily expandable modular system in a vibrant and interesting design, yet timeless and classical enough that it would stand the test of time. Combine Punctual Ladders, Shelves and Boxes to form your ideal shelving unit that meets your specific needs.

The system is easy to assemble, comes in a range of beautifully soft colour hues and can be used for storing everything from books, boxes, shoes and toys to kitchenware, works of art or beautiful plants. The design registered structure is strong and robust, with a clear reference to industrial shelving systems.

With the new Wooden and Solid Metal Shelves, you have the option of customizing the system even further.

PRODUCT DETAILS

Product type: Modular shelving system for indoor use only.
For contract sales and contract use please contact us for further information

Origin: Europe

Construction: All parts are made in highly durable powder coated metal. The powder coating is developed by one of the world's leading paint companies in Norway. This highly durable powder coating is made for outdoor facades and buildings, and is therefore an extremely durable coating to be used indoor.

firm LIVING is determined to ensure a shelving system that will last for several years without compromising its quality appearance.

Safety: For all shelving systems the safety wall mounting must be firmly installed into the wall. Max. load per shelf is 35 kg

Design: In collaboration with Wild Horse Studio

Warning: Never attempt to climb the shelving system

Assembly: The modular shelving system is made up of the following parts:

- Ladder
- Adjustment feet
- Shelves
- Shelf Box
- Rack
- Cross
- Hex screws
- Hex key
- Assembly manual
- Safety wall mounting (for extra high shelving system only)

Step-by-step:

1. Attach the lowest shelf to one ladder.
2. Then attach the same shelf to the second ladder.
3. Attach the cross(es) at the back using the enclosed hex screws and key.
4. Attach one more shelf on the following level upwards and continue this way until all shelves and cross(es) are in place.
5. Depending on your flooring, you can align the shelving system by turning the adjustment feet.

Add-on horizontally:

1. Attach the lowest shelf to the existing ladder.
2. Then attach the same shelf to the third ladder.

After three months please check if the screws need to be tightened.

CARE AND CLEANING

Care instructions: Clean with a damp cloth tightly wrung out in clean water. Then polish with a soft, dry cloth. Use a mild solution of universal cleaning agent.



Below are six of our favourite Punctual Shelving System combinations – but the possibilities are endless, it's up to you to find the combination that works for you.

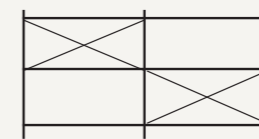

FOR THIS COMBINATION WE USED
 3 x Ladder^{m3}
 6 x Punctual Shelves
 2 x Crosses

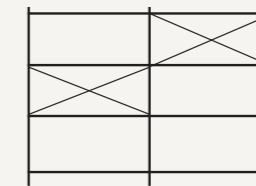

FOR THIS COMBINATION WE USED
 3 x Ladder^{m4}
 8 x Punctual Shelves
 2 x Crosses

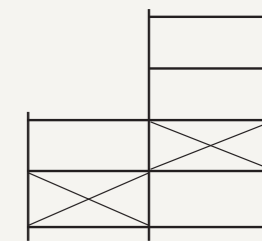

FOR THIS COMBINATION WE USED
 1 x Ladder^{m3}
 2 x Ladder^{m5}
 8 x Punctual Shelves
 2 x Crosses

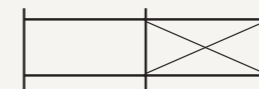

FOR THIS COMBINATION WE USED
 3 x Ladder^{m2}
 4 x Punctual Shelves
 1 x Crosses

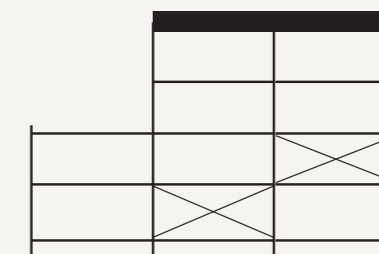

FOR THIS COMBINATION WE USED
 3 x Ladder^{m5}
 1 x Ladder^{m3}
 13 x Punctual Shelves
 2 x Punctual Shelf Boxes
 2 x Crosses

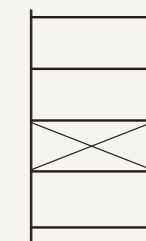

FOR THIS COMBINATION WE USED
 2 x Ladder^{m5}
 5 x Punctual Shelves
 1 x Crosses

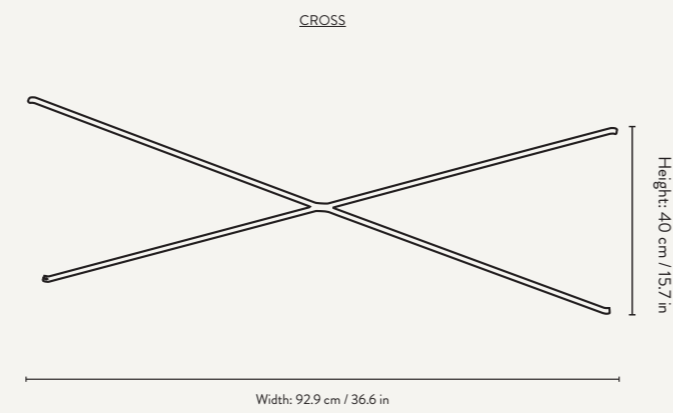
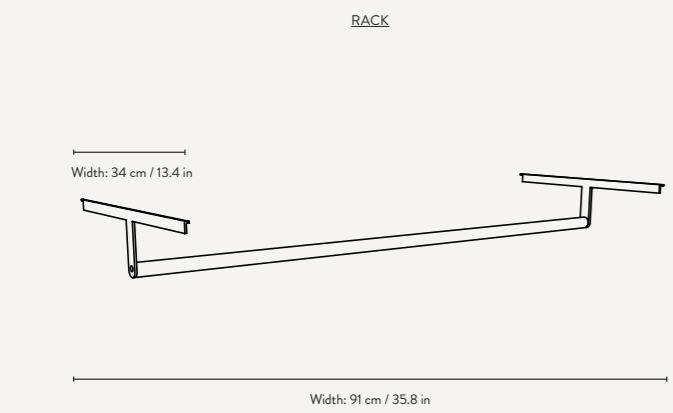
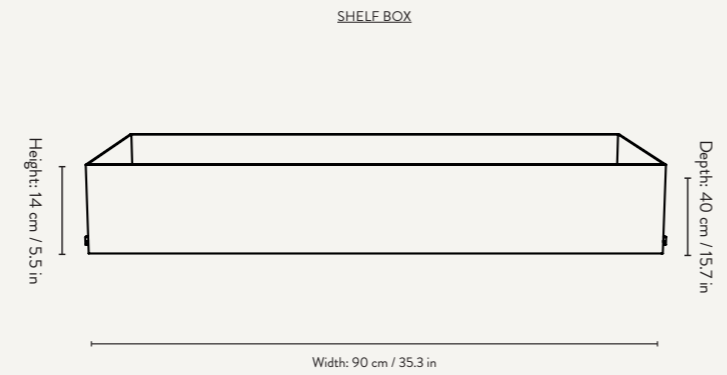
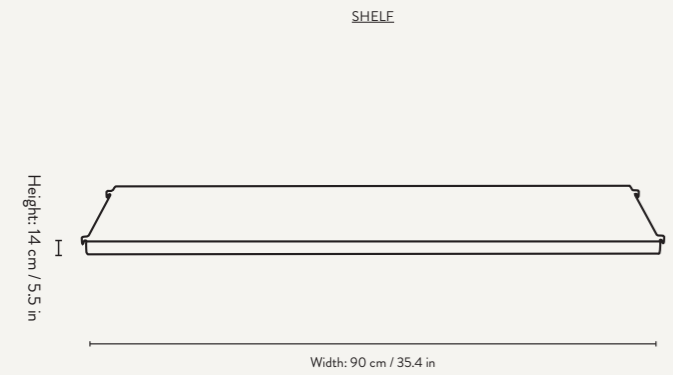
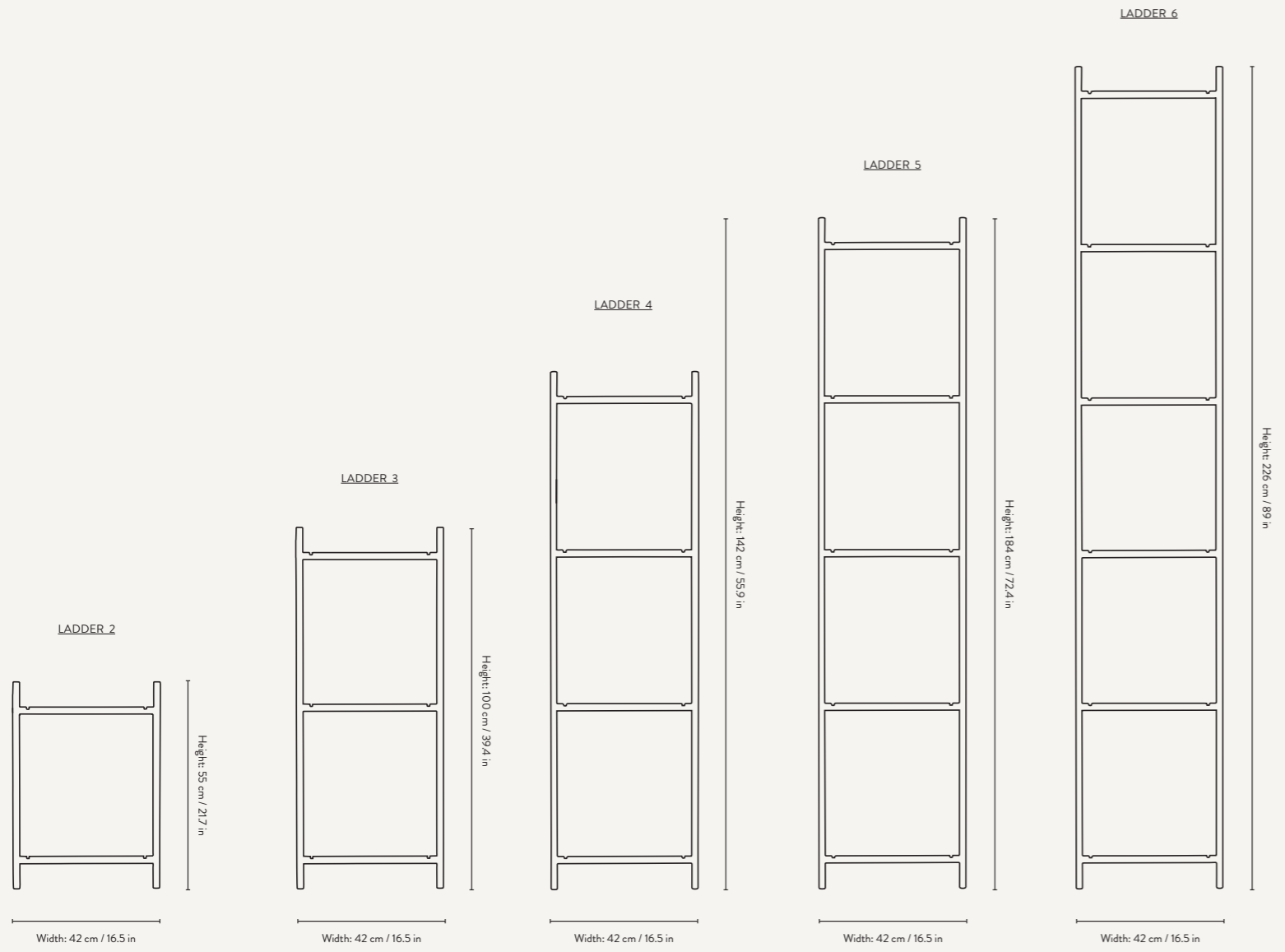



1104263092
Anthracite

110074693
Cashmere

960051
Light Grey

PUNCTUAL - LADDER 2

Size: H: 55 x W: 2 x D: 42 cm
H: 21.7 x W: 0.8 x D: 16.5 in
Material: Powder coated steel
Care: Wipe with a damp cloth
Info: For all shelving systems the safety wall bracket must be firmly installed into the wall. Max. load per shelf is 35 kg. Never attempt to climb the shelving system. Registered design
Design: Collaboration with Wild Horse Studio
Net. weight: 2.5 kg
Packsize: 1

Recommended retail price	
DKK	799
SEK	1.139
NOK	1.139
EUR	105
GBP	99
USD	149

With its industrial-inspired design, the Punctual series is a sleek and classic yet durable modular shelving system available in an endless range of configurations to suit every need. Easy to assemble and made to last, the Punctual series is crafted from durable, powder coated metal.



- NEW
1104263093
Anthracite
- 110075693
Cashmere
- 960052
Light Grey

PUNCTUAL - LADDER 3

Size: H: 100 x W: 2 x D: 42 cm
H: 39.4 x W: 0.8 x D: 16.5 in
Material: Powder coated steel
Care: Wipe with a damp cloth
Info: For all shelving systems the safety wall bracket must be firmly installed into the wall. Max. load per shelf is 35 kg. Never attempt to climb the shelving system. Registered design
Design: Collaboration with Wild Horse Studio
Net. weight: 2.8 kg
Packsize: 1

Recommended retail price	
DKK	849
SEK	1.215
NOK	1.215
EUR	115
GBP	109
USD	159

PUNCTUAL - LADDER 4

Size: H: 142 x W: 2 x D: 42 cm
H: 55.9 x W: 0.8 x D: 16.5 in
Material: Powder coated steel
Care: Wipe with a damp cloth
Info: For all shelving systems the safety wall bracket must be firmly installed into the wall. Max. load per shelf is 35 kg. Never attempt to climb the shelving system. Registered design
Design: Collaboration with Wild Horse Studio
Net. weight: 4.3 kg
Packsize: 1

Recommended retail price	
DKK	949
SEK	1.355
NOK	1.355
EUR	125
GBP	119
USD	179



- NEW
1104263094
Anthracite
- 1104262971
Cashmere
- 1104262972
Light Grey



- NEW
1104263095
Anthracite
- 110077693
Cashmere
- 960053
Light Grey

PUNCTUAL - LADDER 5

Size: H: 184 x W: 2 x D: 42 cm
H: 72.4 x W: 0.8 x D: 16.5 in
Material: Powder coated steel
Care: Wipe with a damp cloth
Info: For all shelving systems the safety wall bracket must be firmly installed into the wall. Max. load per shelf is 35 kg. Never attempt to climb the shelving system. Registered design
Design: Collaboration with Wild Horse Studio
Net. weight: 4.6 kg
Packsize: 1

Recommended retail price	
DKK	999
SEK	1.425
NOK	1.425
EUR	135
GBP	129
USD	189



- NEW
1104263096
Anthracite
- 110078693
Cashmere
- 960055
Light Grey

PUNCTUAL - LADDER 6

Size: H: 226 x W: 2 x D: 42 cm
H: 89 x W: 0.8 x D: 16.5 in
Material: Powder coated steel
Care: Wipe with a damp cloth
Info: For all shelving systems the safety wall bracket must be firmly installed into the wall. Max. load per shelf is 35 kg. Never attempt to climb the shelving system. Registered design
Design: Collaboration with Wild Horse Studio
Net. weight: 5.5 kg
Packsize: 1

Recommended retail price	
DKK	1.049
SEK	1.499
NOK	1.499
EUR	139
GBP	135
USD	195

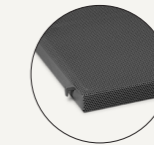
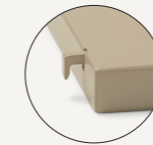

- NEW
1104263306
Anthracite
- 1104263195
Cashmere
- 1104263196
Light Grey

- NEW
1104263097
Anthracite
- 110079693
Cashmere
- 960051-1
Light Grey

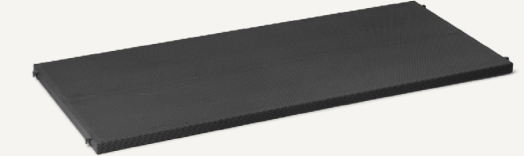

PUNCTUAL - SOLID METAL SHELF

Size: H: 2.3 x W: 90 x D: 39.6 cm
H: 0.9 x W: 35.4 x D: 15.6 in

Material: Powder coated steel

Care: Wipe with a damp cloth

Info: For all shelving systems the safety wall bracket must be firmly installed into the wall. Max. load per shelf is 35 kg. Never attempt to climb the shelving system. Registered design

Design: Collaboration with Wild Horse Studio

Net. weight: 3.5 kg

Packsizes: 1

Recommended retail price	
DKK	699
SEK	999
NOK	999
EUR	95
GBP	89
USD	129

PUNCTUAL - PERFORATED METAL SHELF

Size: H: 2.3 x W: 90 x D: 39.6 cm
H: 0.9 x W: 35.4 x D: 15.6 in

Material: Powder coated steel

Care: Wipe with a damp cloth

Info: For all shelving systems the safety wall bracket must be firmly installed into the wall. Max. load per shelf is 35 kg. Never attempt to climb the shelving system. Registered design

Design: Collaboration with Wild Horse Studio

Net. weight: 3.5 kg

Packsizes: 1

Recommended retail price	
DKK	799
SEK	1.139
NOK	1.139
EUR	105
GBP	99
USD	149

NEW

- NEW
1104263307
Anthracite
- 1104262973
Cashmere
- 1104262974
Light Grey

- NEW
1104263091
Anthracite
- 110080693
Cashmere
- 960050
Light Grey



PUNCTUAL - RACK

Size: H: 8 x W: 34 x D: 91 cm
H: 3.1 x W: 13.4 x D: 35.8 in

Material: Powder coated steel

Care: Wipe with a damp cloth

Info: For all shelving systems the safety wall bracket must be firmly installed into the wall. Max. load per shelf is 35 kg. Never attempt to climb the shelving system. Registered design

Design: Collaboration with Wild Horse Studio

Net. weight: 2.8 kg

Packsizes: 1

Recommended retail price	
DKK	699
SEK	999
NOK	999
EUR	95
GBP	89
USD	129

PUNCTUAL - CROSS

Size: H: 40 x W: 93 x D: 1.6 cm
H: 15.7 x W: 36.6 x D: 0.6 in

Material: Powder coated steel

Care: Wipe with a damp cloth

Info: For all shelving systems the safety wall bracket must be firmly installed into the wall. Max. load per shelf is 35 kg. Never attempt to climb the shelving system. Registered design

Design: Collaboration with Wild Horse Studio

Net. weight: 0.8 kg

Packsizes: 1

Recommended retail price	
DKK	299
SEK	425
NOK	425
EUR	39
GBP	39
USD	55



- NEW
1104263952
Smoked Oak/
Anthracite
- 1104263951
Natural Oak/
Anthracite
- 1104263242
Smoked Oak/
Cashmere
- 1104263240
Natural Oak/
Cashmere
- 1104263241
Smoked Oak/
Light Grey
- 1104263239
Natural Oak/
Light Grey

- NEW
1104263098
Anthracite
- 110281693
Cashmere
- 110283103
Light Grey



PUNCTUAL - WOODEN SHELF

Size: H: 2.3 x W: 40 x D: 89.6 cm
H: 0.9 x W: 15.7 x D: 35.3 in

Material: Oiled oak veneer

Care: Wipe with a damp cloth. Do not leave the surface wet

Info: For all shelving systems the safety wall bracket must be firmly installed into the wall. Max. load per shelf is 35 kg. Never attempt to climb the shelving system. Registered design

Design: Collaboration with Wild Horse Studio

Net. weight: 5.4 kg

Packsizes: 1

Recommended retail price	
DKK	799
SEK	1.139
NOK	1.139
EUR	105
GBP	99
USD	149

PUNCTUAL - SHELF BOX

Size: H: 14 x W: 89.6 x D: 40 cm
H: 5.5 x W: 35.3 x D: 15.7 in

Material: Powder coated steel

Care: Wipe with a damp cloth

Info: For all shelving systems the safety wall bracket must be firmly installed into the wall. Max. load per shelf is 35 kg. Never attempt to climb the shelving system. Registered design

Design: Collaboration with Wild Horse Studio

Net. weight: 9.6 kg

Packsizes: 1

Recommended retail price	
DKK	999
SEK	1.425
NOK	1.425
EUR	135
GBP	129
USD	189



Life is full of contrasts

As we navigate expectations and dreams in the search for meaning and comfort, we long for a balanced life with room for chaos and calm, moments of reflection and times of joy. A place where we can be ourselves, realise the true value of things and feel at home.

Based on a passion for authentic design and clear functionality, we challenge ourselves to shape the future and take pride in creating products that help you balance the contrasts of life.

Our soft forms, rich textures and deep colours allow you to create an authentic and composed atmosphere, while avant-garde shapes, striking patterns and curious details add a touch of the unexpected.

From our base in Copenhagen, we work with artisans around the world, fusing our Scandinavian mindset with global skills and traditions. We take our responsibility to people and the planet seriously and expect the same of our partners.

We create collections of furniture, accessories and lighting, so you can create space to feel comfortably you.

Welcome home.

